

Fresh Water Controller MFWC

Installation and operating instructions

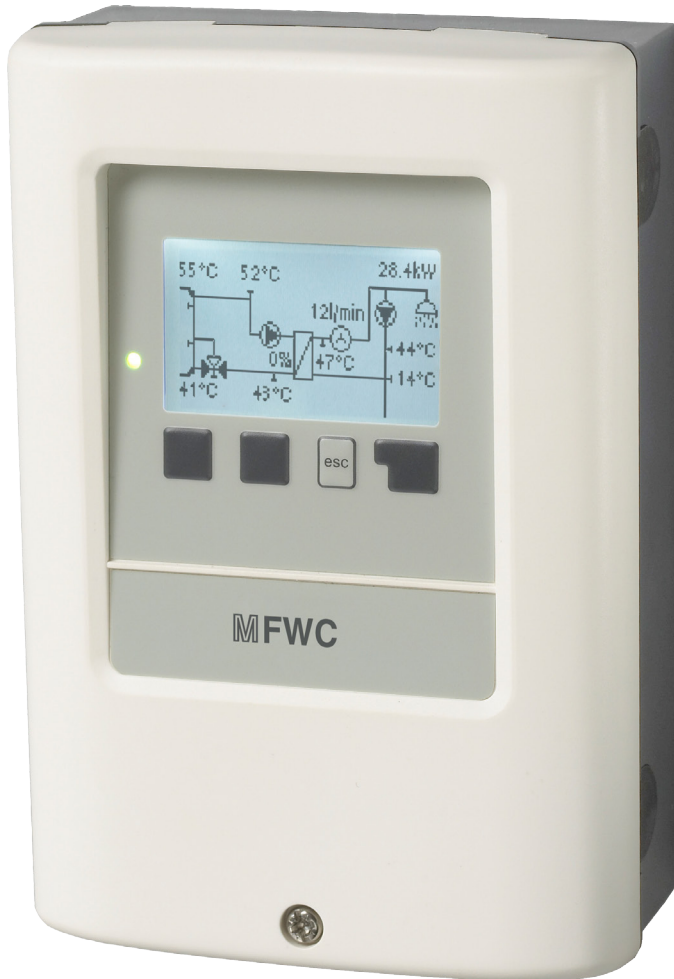

Read carefully before installation, commissioning and operation

Contents

A. Safety instructions	3	5. Protections / Protective functions	23
A.1. EC declaration of conformity	3	5.1. Antilegionella	23
A.2. General instructions	3	5.2. Limescale Protection	24
A.3. Explanation of symbols	3	5.3. Discharge Protection	24
A.4. Changes to the unit	4	5.4. Seizing protection	24
A.5. Warranty and liability	4		
B. Description of controller	5	6. Special functions	25
B.1. Specifications	5	6.1. Pump menu	25
B.2. Temperature resistance table for Pt1000 sensors	5	6.1.1. Type of pump	25
B.3. About the controller	6	6.1.2. Pump	25
B.4. Scope of supply	6	6.1.3. Output Signal	25
B.5. Disposal and pollutants	6	6.1.4. 0-10V off / PWM off	25
B.6. Hydraulic variants	7	6.1.5. 0-10V on / PWM on	26
		6.1.6. 0-10V Max / PWM Max	26
C. Installation	8	6.1.7. Show signal	26
C.1. Wall installation	8	6.2. Speed control R1 / R2	26
C.2. Electrical connection	9	6.2.1. max. speed	26
C.3. Electrical connection	10	6.2.2. min. speed	26
C.4. Installing the temperature sensors	11	6.5. Relay functions	27
		6.5.1. Circulation	27
D. Terminal connection diagrams	12	6.5.2. Storage heating	27
		6.5.2.1.Storage heating	27
E. Operation	13	6.5.2.2.Storage minimum temperature	27
E.1. Display and input	13	6.5.2.3.SH Setpoint Temperature	27
E.2. Menu sequence and menu structure	14	6.5.2.4.SH hysteresis	27
		6.5.2.5.Periods	27
F. Parametrisation	15	6.5.3. Storage stratification	28
F.1. Commissioning help	15	6.5.3.1.Storage stratification	28
F.2. Free commissioning	15	6.5.3.2.ΔT return storage	28
F.3. Calibration	16	6.5.4. Parallel operation V1	28
		6.5.4.1.Parallel operation V1	28
1. Measurement values	17	6.5.4.2.Delay	28
		6.5.4.3.Followup time	28
2. Statistics	18	6.5.5. Parallel operation V2	28
2.1. Operating hours HW	18	6.5.6. Always on	28
2.2. Operating hours circ.	18	6.6. Relay 2	28
2.3. Heat output	18	6.7. Relay 3	28
2.4. Graphic overview	18	6.8. Signal V2	29
2.5. Error messages	18	6.8.1. Signal V2	29
2.6. Reset / clear	18	6.9. Pressure monitor	29
		6.9.1. Pressure monitor	29
3. Operating mode	19	6.9.2. RPS1 / RPS2	29
3.1. Automatic	19	6.9.3. Pmin	29
3.2. Manual	19	6.9.4. Pmax	29
3.3. Off	19	6.10. Sensor calibration	30
		6.11. Commissioning	30
4. Settings	20	6.12. Factory settings	30
4.1. Tset	20	6.13. Time & Date	30
4.2. Tmax	20	6.14. Daylight saving time	31
4.3. VFS -Type	20	6.15. Sleep mode	31
4.4. Circulation	21	6.16. Temperature unit	31
4.4.1. Circulation	21		
4.4.2. Circ. Tmin.	21	7. Menu lock	32
4.4.3. Circ. hysteresis	21	7.1. Menu lock	32
4.4.4. Circ. maximum Flow rate	21	7.2. Expert mode	32
4.4.5. Circulation period	21		
4.4.6. Tap support	22	8. Service values	33
4.4.7. Min storage temp	22		
4.4.8. Tap support calibration	22	9. Language	34
4.6. Zone valve	22		
4.12. Comfort	22	Z. Malfunctions	35
		Z.1. Malfunctions with error messages	35
		Z.2. Replacing the fuse	36
		Z.3. Maintenance	37

Safety instructions

A.1. - EC declaration of conformity

By affixing the CE mark to the unit the manufacturer declares that the MFWC conforms to the following relevant safety regulations:

- EC low voltage directive 2006/95/EC
- EC electromagnetic compatibility directive 2004/108/EC

Conformity has been verified and the corresponding documentation and the EC declaration of conformity are kept on file by the manufacturer.

A.2. - General instructions

It is essential that you read this!

These installation and operating instructions contain basic instructions and important information regarding safety, installation, commissioning, maintenance and the optimal use of the unit. Therefore these instructions must be read completely and understood by the installation technician/ specialist and by the system user before installation, commissioning and operation of the unit. The valid accident prevention regulations, VDE regulations, the regulations of the local power utility, the applicable DIN-EN standards and the installation and operating instruction of the additional system components must also be observed. The controller does not under any circumstances replace any safety devices to be provided by the customer! Installation, electrical connection, commissioning and maintenance of the unit may only be carried out by specialists who possess the appropriate training.

For the user: Make sure that the specialist gives you detailed information on the function and operation of the controller. Always keep these instructions in the vicinity of the controller.

A.3. - Explanation of symbols



Failure to observe these instructions can result in danger to life from electric voltage.



Failure to observe these instructions can result in serious damage to health such as scalding, or even life-threatening injuries.



Failure to observe these instructions can result in destruction of the unit or the system, or damage to the environment.



Information which is especially important for the function and optimal use of the unit and the system.

Safety instructions

A.4. - Changes to the unit



Changes to the unit can compromise the safety and function of the unit or the entire system.

- Changes, additions to or conversion of the unit are not permitted without the written permission from the manufacturer
- It is likewise forbidden to install additional components that have not been tested together with the unit
- If it becomes clear that safe operation of the unit is no longer possible, for example because of damage to the housing, then turn the controller off immediately
- Any parts of the unit or accessories that are not in perfect condition must be exchanged immediately
- Use only original spare parts and accessories from the manufacturer.
- Markings made on the unit at the factory must not be altered, removed or made illegible
- Only the settings actually described in these instructions may be made on the controller

A.5. - Warranty and liability

The controller has been manufactured and tested with regard to high quality and safety requirements. The unit is subject to the statutory guarantee period of two years from the date of sale.

The warranty and liability shall not include, however, any injury to persons or material damage that is attributable to one or more of the following causes:

- Failure to observe these installation and operating instructions
- Improper installation, commissioning, maintenance and operation
- Improperly executed repairs
- Unauthorised structural changes to the unit
- Installation of additional components that have not been tested together with the unit
- Any damage resulting from continued use of the unit despite an obvious defect
- Failure to use original spare parts and accessories
- Use of the device for other than its intended purpose
- Operation above or below the limit values listed in the specifications
- Force majeure

Description of controller

B.1. - Specifications

Electrical specifications:

Mains voltage	100 - 240VAC
Mains frequency	50 - 60Hz
Power consumption	0,5W - 2,5W
Internal fuse	T2A / 250V slow blow
Protection category	IP40
Protection class	II
Overvoltage Category	II
Degree of Pollution Category	II

mechanical relay 460VA for AC1 / 460W for AC3	3 (R1-R3)	
0-10V output, tolerance 10%, 10 k Ω load or PWM output freq. 1 kHz, level 10 V	2	
PT1000 sensor input measuring range -40°C to 300°C	6	
VFS / RPS inputs 0°C-100°C (-25°C /120°C short term)	2	
1 l/min - 12 l/min (VFS1-12)		0-0,6 bar
1 l/min - 20 l/min (VFS1- 20)		0-1 bar
2 l/min - 40 l/min (VFS2-40)		0-1,6 bar
5 l/min - 100 l/min (VFS5-100)		0-2,5 bar
10 l/min - 200 l/min (VFS10-200)	0-4 bar 0-6 bar 0-10 bar	

Permissible cable length of sensors and appliances:

other PT1000 sensors	<10m
VFS/RPS Sensoren	<3m
CAN	<3m
PWM / 0...10V	<3m
mechanical relay	<10m

Real Time Clock

RTC with 24 hour power reserve

Permissible ambient conditions:

Ambient temperature	
for controller operation	0°C...40°C
for transport/storage	0°C...60°C
Air humidity	
for controller operation	max. 85% rel. humidity at 25°C
for transport/storage	no moisture condensation permiddled

Other specifications and dimensions

Housing design	2-part, ABS plastic
Installation methods	Wall installation, optionally panel installation
Overall dimensions	163mm x 110mm x 52mm
Aperture installation dimensions	157mm x 106mm x 31mm
Display	Fully graphical display, 128 x 128 dots
Light diode	Multicolor red/green
Operation	4 entry keys

B.2. - Temperature resistance table for Pt1000 sensors

°C	0	10	20	30	40	50	60	70	80	90	100
Ω	1000	1039	1077	1116	1155	1194	1232	1270	1308	1347	1385

Description of controller

B.3. - About the controller

The Fresh water controller MFWC facilitates efficient use and function control through of your fresh water system. Tap water temperature is regulated fast and precise. The device is impressive most of all for its functionality and simple, almost self-explanatory operation. For each step in the input process the individual entry keys are assigned to appropriate functions and explained. The controller menu contains headwords for the measured values and settings, as well as help texts or clearly-structured graphics.

Important characteristics of the MFWC:

- Depiction of graphics and texts in a lighted display
- Simple viewing of the current measurement values
- Analysis and monitoring of the system by means of statistical graphics, etc.
- Extensive setting menus with explanations
- Menu block can be activated to prevent unintentional setting changes
- Resetting to previously selected values or factory settings

B.4. - Scope of supply:

- Fresh water controller MFWC
- replacement fuse 2A slow-blow
- Installation and operating instructions MFWC

Optionally contained depending on design/order:

- Pt1000 temperature sensor and Vortex Flow Sensor
- External relay with potential free contact article number 77502

B.5. - Disposal and pollutants

The unit conforms to the European RoHS directive 2011/65/EU for the restriction of the use of certain hazardous substances in electrical and electronic equipment.



The unit must not under any circumstances be disposed of with ordinary household refuse. Dispose of the unit only at appropriate collection points or ship it back to the seller or manufacturer.

Description of controller

B.6. - Hydraulic variants



The following illustrations should be viewed only as schematic diagrams showing the respective hydraulic systems, and do not claim to be complete. The controller does not replace safety devices under any circumstances. Depending on the specific application, additional system components and safety components may be mandatory, such as check valves, non-return valves, safety temperature limiters, scalding protectors, etc., and must therefore be provided.

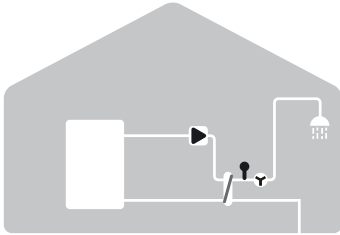

Basic scheme

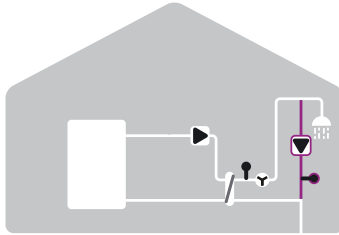

Additional function circulation

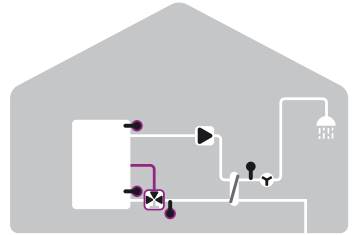

Additional function storage stratification

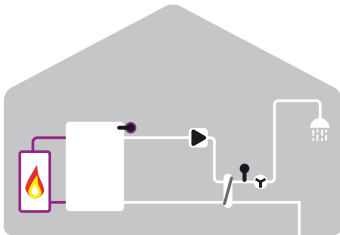

Additional function storage heating

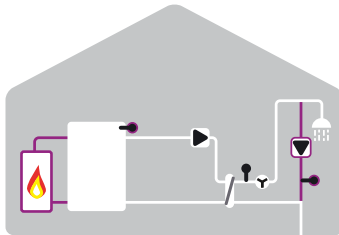

Additional functions storage heating and circulation

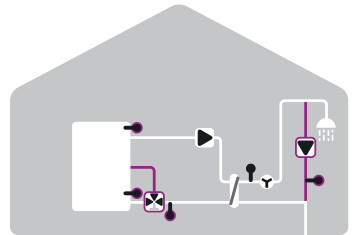

Additional functions storage stratification and storage heating

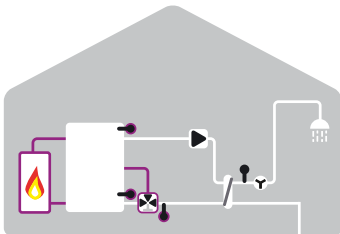

Additional functions storage stratification and storage heating

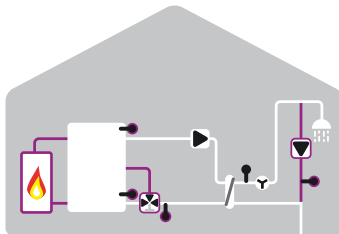

Additional functions circulation, storage stratification and storage heating

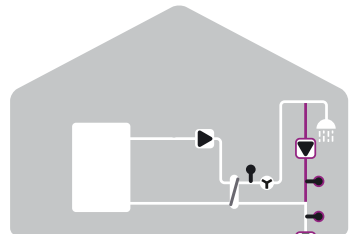

Additional functions cascade and circulation

Installation

C.1. - Wall installation



Install the controller only in dry areas and under the ambient conditions described under 2.1 "Specifications". Carry out the following steps 1-8.

Fig.C.1.1

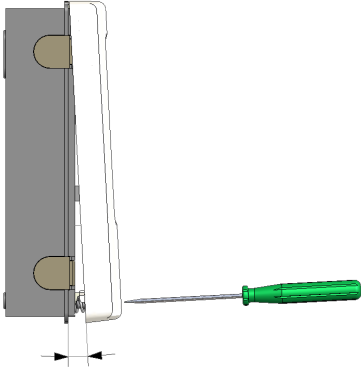

1.Unscrew cover screw completely

2.Carefully pull upper part of housing from lower part.

3.Set upper part of housing aside, being sure not to touch the electronics when doing so.

4.Hold the lower part of the housing up to the selected position and mark the 3 mounting holes. Make sure that the wall surface is as even as possible so that the housing does not become distorted when it is screwed on.

Fig.C.1.2

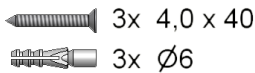

5.Using a drill and size 6 bit, drill 3 holes at the points marked on the wall and push in the plugs.

6.Insert the upper screw and screw it in slightly.

7.Fit the upper part of the housing and insert the other two screws.

8. Align the housing and tighten the three screws.

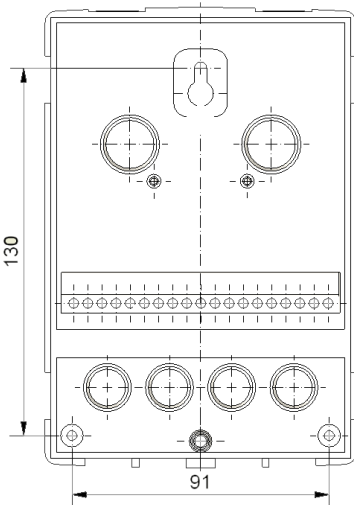

Installation

C.2. - Electrical connection



Before working on the unit, switch off the power supply and secure it against being switched on again! Check for the absence of power! Electrical connections may only be made by a specialist and in compliance with the applicable regulations. Do not use the controller if the housing shows visible damage.



Low-voltage cables such as temperature sensor cables must be routed separately from mains voltage cables. Feed temperature sensor cables only into the left-hand side of the unit, and mains voltage cables only into the right-hand side.



The customer must provide an all-pole disconnecting device, e.g. a heating emergency switch.



The cables being connected to the unit must not be stripped by more than 55mm, and the cable jacket must reach into the housing just to the other side of the strain relief.



Controller and VFS sensor have to have the same ground potential. The VFS sensor uses a functional earth connector (PELV). The PE-connector of the controller has to be connected to the pipe system near the sensor.

Installation

C.3. - Electrical connection

C.3.1.

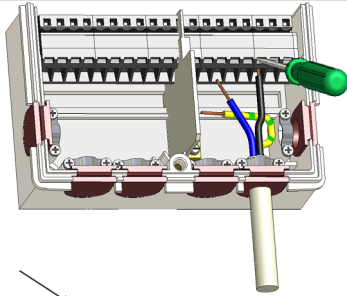

C.3.2.

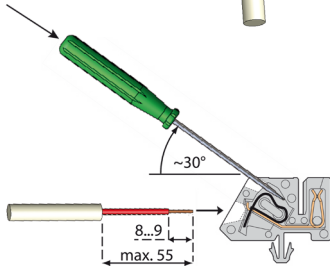

1. Select necessary program/ hydraulics
2. Open controller
3. Strip cables by 55mm max., insert, fit the strain relief devices, strip the last 8-9mm of the wires. (Fig. C.3.1)
4. Open the terminals using a suitable screwdriver (Fig. C.3.2) and make electrical connections on the controller
5. Connect the flow sensor to the socket on the board (Fig. C.3.3.).
6. Refit upper part of housing and fasten with screw.
7. Switch on mains voltage and place controller in operation.

C.3.3.



Installation

C.4. - Installing the temperature sensors

The controller operates with Pt1000 temperature sensors which are accurate to the degree, thus ensuring optimal control of system functions.

Position the sensor precisely in the area to be measured!

It is recommended that at least 20 cm of the sensor cable at the sensor are installed inside the pipe insulation.

Connect the VFS sensors with the matching jacks.



Caution

Sensor cables for PT1000 can be extended to a maximum of 10m using a cable with a cross-section of at least 0.75mm².

Sensor cables for the VFS sensor can be extended to 3m.

Make sure that there is no contact resistance!



Caution

The temperature sensor cables must be routed separately from mains voltage cables, and must not, for example, be routed in the same cable duct!



Attention

It must be ensured on site that the piping system is grounded properly and at the same potential as the protective conductor of the controller.



Caution

Controller and VFS sensor have to have the same ground potential. The VFS sensor uses a functional earth connector (PELV). The PE-connector of the controller has to be connected to the pipe system near the sensor.

Example:

Connections and dimensions of the Vortex Flow Sensors VFS2-40

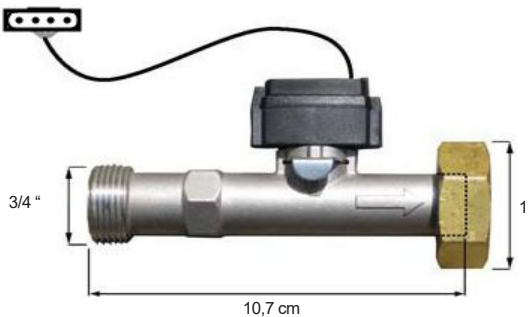

Installation

D. - Terminal connection diagrams

D.1. - „With circulation pump“



Sensor side
max. 12V



Mains side
230VAC

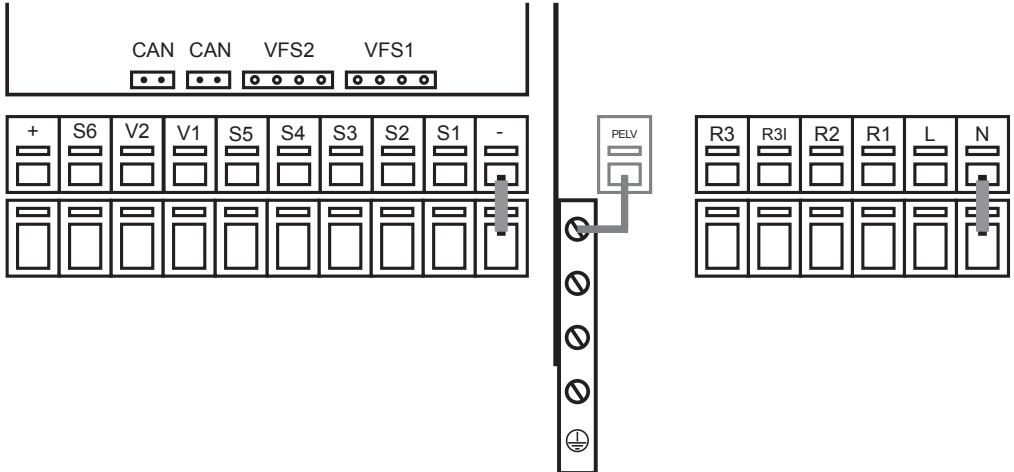

Low voltage max. 12VAC/DC connection in the left-hand terminal compartment!

Terminal: Connection for:

S1	Circulation (opt.)
S2	Cold water (optional, see box below)
S3	Primary flow (opt.)
S4	Storage top (opt.)
S5	storage middle (opt.)
V1	0-10V/PWM signal primary pump
V2	0-10V/PWM signal (opt.)
S6	Primary return flow (opt.)
-	Terminal connection sensor -
VFS1	Warm water tap
VFS2	optional

Mains voltages 230VAC 50-60Hz

Connection in the right-hand terminal compartment!

Terminal: Connection for:

L	Mains phase conductor L
N	Mains neutral conductor N
R1	Primary pump (opt.)
R2	Relay 2
R3	Relay 3 (normally open)
R3I	Relay 3 (normally closed)

The PE protective conductor must be connected to the PE metal terminal block!

The polarity of the sensors is freely selectable.

Relay connection changes depending on the additional functions selected.

Connection of sensor earths (1-6) via terminal block sensor(-)

VFS sensor has to be connected to the socket on the circuit board.

Sensor 2 / Cold water: If no sensor is connected, a temperature of 10° C is set. See also „6.2 Sensor calibration“

Operation

E.1. - Display and input

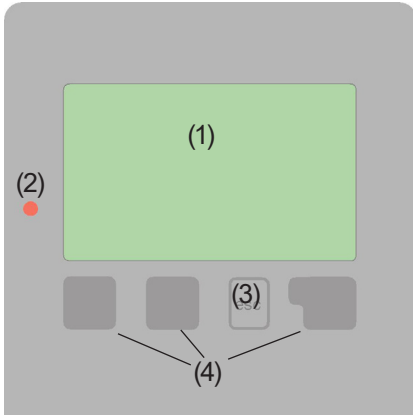

The display (1), with its extensive text and graphics mode, is almost self-explanatory, allowing easy operation of the controller.

The LED (2) lights up green when a relay is switched on.









The LED (2) lights up red when operating mode "Off" is set.

The LED (2) flashes slowly red in the operating mode "Manual".

The LED (2) flashes quickly red when an error is present.

Entries are made using four keys (3+4), which are assigned to different functions depending on the situation. The "esc" key (3) is used to cancel an entry or to exit a menu. If applicable there will be a request for confirmation as to whether the changes which have been made should be saved. The function of each of the other three keys (4) is shown in the display line directly above the keys; the right-hand key is generally has a confirmation and selection function.

Examples of display symbols:

-  Pump
(rotates in operation)
-  Flow meter
-  heat exchanger
-  Temperature sensor
-  Warning/error message
-  New information available
-  Valve (flow direction black)
-  Thermostat

Examples of key functions:

- +/- = enlarge/shrink values
- ▼/▲ = scroll menu down/up
- yes/no = approve/reject
- Info = additional information
- Back = to previous screen
- ok = confirm selection
- Confirm = confirm setting

Operation

E.2. - Menu sequence and menu structure

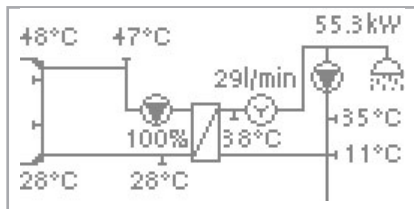

The graphics or overview mode appears when no key has been pressed for 2 minutes, or when the main menu is exited by pressing "esc".



Pressing a key in graphics or overview mode takes you directly to the main menu. The following menu items are then available for selection there:



1. Measurement Values

Current temperature values with explanations

2. Statistics

Function control of the system with operating hours, etc.

3. Display mode

Select graphics mode or overview mode

4. Operating mode

Automatic mode, manual mode or switch unit off

5. Settings

Set parameters needed for normal operation

6. Special functions

Program selection, clock, etc.

7. Protective functions

Functions to prevent damage to system and user.

8. Menu block

Against unintentional setting changes at critical points

9. Service Values

For diagnosis in the event of an error

Parametrisation

F.1. - Commissioning help



The first time the controller is turned on and after the language and time are set, a query appears as to whether you want to parametrise the controller using the commissioning help or not. The commissioning help can also be terminated or called up again at any time in the special functions menu. The commissioning help guides you through the necessary basic settings in the correct order, and provides brief descriptions of each parameter in the display. Pressing the “esc” key takes you back to the previous value so you can

look at the selected setting again or adjust it if desired. Pressing the “esc” more than once takes you back step by step to the selection mode, thus cancelling the commissioning help. Finally, menu 4.2 under operating mode “Manual” should be used to test the switch outputs with the consumers connected, and to check the sensor values for plausibility. Then switch on automatic mode.



Caution

Observe the explanations for the the individual parameters on the following pages, and check whether further settings are necessary for your application.

F.2. - Free commissioning

If you decide not to use the commissioning help, you should make the necessary settings in the following sequence:

- Menu 6. Special functions - clock, Additional functions
- Menu 5. Settings, complete

Finally, menu 4.2 under operating mode “Manual“ should be used to test the switch outputs with the consumers connected, and to check the sensor values for plausibility. Then switch on automatic mode.



Caution

Observe the explanations for the the individual parameters on the following pages, and check whether further settings are necessary for your application.

Parametrisation

F.3. - Calibration

When the tap support is activated (during commissioning or in the menu „Circulation“), a calibration process is started after the commissioning. To ensure the correct operation, calibration is also scheduled to start on every Sunday at 3:00 AM.

During commissioning, the calibration must not be interrupted.

If the weekly calibration process is not successful after 10 minutes, the process is cancelled and the controller uses the former calibration values.

Calibration

During the calibration process a text is shown that the flow rate is measured and no tapping is allowed.

After confirmation the circulation pump is switched off and the controller is waiting until the flow rate has dropped to 0 L/min. Afterwards only the circulation pump is switched on and after another 60 seconds the flow rate is measured. The display shows a “Please wait” sign.

After another minute, the flow rate is measured again, and the two flow rates are compared.

If the results are identical (± 1 L/min), the result is saved.

If not, the process is started over until either the results match or 10 minutes have passed and the calibration is cancelled and the former values are used.

Measurement values

1. - Measurement values



The menu “1. Measurement values” serves to display the currently measured temperatures.

The menu is closed by pressing “esc” or selecting “Exit measurement values”.



If “Error” appears on the display instead of the measurement value, then there may be a defective or incorrect temperature sensor.



Caution

If the cables are too long or the sensors are not placed optimally, the result may be small deviations in the measurement values. In this case the display values can be compensated for by making entries on the controller. Follow the instructions under 12.3.

What measurement values are displayed depends on the selected program, the connected sensors and the specific device design.

Statistics

2. - Statistics



The menu “2. Statistics” is used for function control and long-term monitoring of the system. The submenus described under 7.1-7.6 are available.

The menu is closed by pressing “esc” or selecting “Exit statistics”.



Caution

For system data statistics it is essential for the time to be set accurately on the controller. Please note that the clock continues to run for about 24 hours if the mains voltage is interrupted, and after that has to be reset. Improper operation or an incorrect time may result in data being cleared, recorded incorrectly or overwritten. The manufacturer accepts no liability for the recorded data!

2.1. - Operating hours HW

Display of operating hours of the relays connected to the controller.

2.2. - Heat output

Display of the heat output of the system in KWh



Caution

Resulting data is only approximate value for function control!

2.3. - Graphic overview

This provides a clearly-organised display of the data listed under 2.1 - 2.2 as a bar graph. Various time ranges are available for comparison. The two left-hand keys can be used to page through the data.

2.4. - Error messages

Display of the last 15 errors occurring in the system with indication of date and time.

2.5. - Reset / clear

Resetting and deleting the individual analyses. The function “All statistics” clears all analyses but not the error messages.

Operating modes

3. - Operating mode



In menu “4. Operating modes” the controller can either be placed in automatic mode, switched off, or placed in a manual operating mode.

The menu is closed by pressing “esc” or selecting “Exit operating modes”.



3.1. - Automatic



Caution

Automatic mode is the normal operating mode of the controller. Only automatic mode provides proper controller function taking into account the current temperatures and the parameters that have been set! After an interruption of the mains voltage the controller automatically returns to the last operating mode selected!

3.2. - Manual



Danger

When operating mode “Manual” is activated, the current temperatures and the selected parameters are no longer considered. There is a danger of scalding or serious damage to the system. The operating mode “Manual” may only be used by specialists for brief function tests or during commissioning! The relay and thus the connected consumer are switched on and off by pressing a key, with no regard to the current temperatures and the parameters which have been set. The measured temperatures are also shown to provide an overview and function control.

3.3. - Off





Caution

When the operating mode “Off” is activated, all controller functions are switched off. The measured temperatures are still displayed to provide an overview.

Settings

4. - Settings

5. Exit settings	
5.1. Tsetpoint	45°C
5.2. TMax	60°C
 	Info

The necessary basic settings required for the control function are made in menu "5. Settings".



This does not under any circumstances replace the safety facilities to be provided by the customer!



The menu is closed by pressing "esc" or selecting "Exit settings".

4.1. - Tset

Setpoint at VFS sensor

The controller MFWC provides this hot water temperature (tap temperature) constant and as soon as possible.

4.2. - Tmax

Setpoint at VFS sensor

The controller MFWC provides this hot water temperature (tap temperature) constant and as soon as possible.



Temperature values which are set too high can lead to scalding or damage to the system. Scalding protection must be provided by the customer!

4.3. - VFS -Type

Set the type of Vortex Flow Sensors

In this menu the type of Vortex Flow Sensor can be set.

Settings

4.4. - Circulation

Settings for circulation.



Circulation settings are only available if the Special Features circulation is set.

4.4.1. - Circulation

Mode of circulation

When the mode “**Request**” is active, the circulation pump is switched on after a corresponding tapping of water has occurred and stays on until the circulation target temperature (Circ Tmin + hysteresis) is reached at the circulation sensor.

In mode “**Periods**” the circulation pump is enabled in the set periods and the set circulation minimum temperature is undershot and stays on until the circulation target temperature (Circ Tmin + hysteresis) is reached at the circulation sensor.

Request+Time: The circulation pump is switched on in the enabled periods and the set circulation minimum temperature is undershot, or when water is tapped. Circulation stays on till the circulation target temperature (Circ Tmin + hysteresis) is reached at the circulation sensor.

Always on: Circulation pump is switched on in set periods.

4.4.2. - Circ. Tmin.

Minimum temperature at sensor S2

If the temperature drops below Circ.Tmin and the circulation is enabled (see „4.4.5. - Circulation period“), the circulation pump is started.

4.4.3. - Circ. hysteresis

Switch-off hysteresis of the circulation pump

If the temperature exceeds TminS2 by this value, the circulation pump is switched off.

4.4.4. - Circ. maximum Flow rate

Maximum flow rate of the circulation pump

If the flow rate measured at sensor 6 exceeds this value (because water is being drained from the system) the circulation pump is switched off.

4.4.5. - Circulation period

Period where the circulation pump is enabled. Set the operation times of the circulation pump. 3 different periods can be set for every weekday, which can also be copied to other days.



This settings 4.4.5. are only available if circulation mode “Periods” or “Request + Time” is choosed.



In periods not defined circulation is inactive.
The set periods are only used in the circulation mode “Periods and “Request + Time””.

Settings

4.4.6. - Tap support

To ensure a constant temperature even with small amount of tap water, the circulation pump can be used as support pump. Not only does the circulation pump switch on under normal conditions, but also when a small tapping occurs. When a storage sensor is connected, tap support is only switched on when the Min storage Temp is reached at the storage sensor.

4.4.7. - Min storage temp

Tap support is deactivated when the storage temperature drops below „Min storage temp“.

4.4.8. - Tap support calibration

See „F3. Calibration“ on page 15.

4.12. - Comfort

If this function is activated, the heat exchanger will rinse for 5 seconds every 15 minutes, so that hot water is available as soon as possible.

Protective functions

5. - Protections / Protective functions



Menu „5. - Protections / Protective functions“ can be used to activate and set various protective functions.



This does not under any circumstances replace the safety facilities to be provided by the customer!

The menu is closed by pressing “esc” or selecting “Exit”.

5.1. - Antilegionella

With the AL-function activated, the MFWC 3 makes it possible to heat the storage in selectable intervals, (AL interval) for the set residence time (AL resid. time), starting at the set time (AL start time) until the temperature AL Tset is reached. The temperature measured at S5 has a reference of AL Tset +5°. For the time the AL function is active, Tmax is set to AL Tset +10° to prevent system shutdown due to high temperature.

Only when a temperature of at least „AL Tset“-5°C is reached at the Hot water sensor and, if present, at the circulation sensor for the time set in „Al resid. time“, the AL function is regarded as successful. This is displayed as “Last AL heat.”. If AL is unsuccessful after 2 hours, the attempt is canceled and will be started again the next day and an error message is displayed.



During the anti-Legionella function the storage tank is heated up to high temperatures which can lead to scalding and damage to the system.



The user has to make sure that the antilegionella function was successful at the set intervals.



Caution

The AL function is switched off by default. A message also containing the date is shown as soon as the AL function was completed successful. We recommend to set the „AL start time“ in a period where little or no withdrawal of water takes place.



The user has to make sure that the storage temperature is AL Tset +5° when starting AL. When the storage sensor S3 is installed: If AL Tset+5° is not reached, the AL function is not started.



This anti-Legionella function does not provide complete protection against Legionella, because the controller is dependent on sufficient energy being fed in.

Protective functions

5.2. - Limescale Protection

To prevent the accumulation of limescale, the circulation pump can continue to rinse the heat exchanger after a tapping for at least 5 seconds or for longest 30 seconds or till the VFS sensor drops below T_{set} .

5.3. - Discharge Protection

If the temperature in the primary circuit is not always guaranteed to suffice, this function is used.

With this function activated:

When no storage sensor is connected:

If the setpoint temperature is not reached after 60 seconds, the currently measured temperature -3°C is used as new setpoint temperature. Once the pump in the primary circuit stops, the setpoint temperature is raised to the set T_{set} again.

When the storage sensor is connected

If the temperature at the storage sensor is smaller than $T_{set} - 5^{\circ}\text{C}$, the target temperature is lowered to the currently measured storage temperature -5°C .

In both cases "Circ Tmin" is lowered to the new setpoint temperature - Circ. hysteresis - 5°C , where "Circ Tmin is not lower than 0°C and not higher than the set Circ Tmin.

5.4. - Seizing protection

If the seizing protection is activated, the controller switches the output in question and the connected consumer on every day at 12:00 (setting "daily") or weekly on Sundays at 12:00 (setting "weekly") for 5 seconds in order to prevent the pump and/or the valve from sticking after an extended stationary period.

Special functions

6. - Special functions



Menu “6. Special functions” is used to set basic items and expanded functions.



Other than the time all settings may only be made by a specialist.

The menu is closed by pressing “esc” or selecting “Exit special functions”.



6.1. - Pump menu

This menu contains the settings for 0-10V or PWM pump.



Caution

The power supply of HE pumps with 0-10V / PWM pumps can be connected to the corresponding relay (V1 -> R1, R2 -> V2), since the relays are switched on and off with the signal.

6.1.1. - Type of pump

The type of speed controlled pump must be entered here following the pumps data sheet.

0-10V: Speed control of e.g. High efficiency pumps by 0-10V signal.

PWM: Speed control of e.g. High efficiency pumps by PWM signal.

6.1.2. - Pump

In this menu, preconfigured profiles for various pumps can be selected. Please note that individual settings are still possible even when a profile has been selected.

6.1.3. - Output Signal

This menu determines the type of pump used: Solar pumps perform at their highest power when the signal is also maxed, heating pump on the other hand are set to highest power wenn the control signal is at the lowest. Solar = normal, heating = Inverted. For 0-10V pump is always to select the “Normal” setting.

6.1.4. - 0-10V off / PWM off

This signal / this voltage is put out when the pump is switched off (Pumps that can detect cable break need a minimum signal).

Special functions

6.1.5. - 0-10V on / PWM on

This signal / this voltage is needed to turn the pump on at minimum speed / minimum voltage.

6.1.6. - 0-10V Max / PWM Max

This determines the output signal / the output voltage for the highest speed of the pump, that is used e.g. during purging or manual operation.

6.1.7. - Show signal

Displays the set signal in text and a graphical diagram.

6.2. - Speed control

The settings in this menu are used to limit the speed of connected 0-10V and PWM pumps.

6.2.1. - max. speed

The maximum speed of the pump is specified here. During the setting the pump runs at the specified speed and the flow rate can be determined.



Caution

The indicated percentages are guide values that may vary to a greater or lesser extent depending on the system, pump and pump stage.

6.2.2. - min. speed

The minimum speed of the pump at relay R1 is specified here. During the setting the pump runs at the specified speed and the flow rate can be determined.



Caution

The indicated percentages are guide values that may vary to a greater or lesser extent depending on the system, pump and pump stage.. 100% is the maximum possible voltage/frequency of the controller.

Special functions

6.5. - Relay functions for free relays

The additional functions explained in this section can be assigned to any relay which is unused in the selected hydraulic scheme. Every additional function can only be used once.

All activated additional functions, for which any parameters can be adjusted, also appear in menu "4. Settings".

In the factory settings (basic hydraulic scheme), **relay 1** is set to "always on" by default.

Relay 2 is taken for the function "circulation" in the basic scheme. Please note that the settings for circulation are only shown in the menu if the function "circulation" is assigned to a relay.

In order to change the assignment of a relay, the previously assigned additional function must be switched off.

Pay special attention to the technical data of the relays („B.1. - Specifications“ on page 5).

6.5.1. - Circulation

Set this function to unused relay. In factory settings, this function is assigned to relay 2. See "4.4.1. Circulation on page 20.

6.5.2. - Storage heating

To heat up the storage on demand, the necessary parameters can be set here.

6.5.2.1. - Storage heating

Activate or deactivate function.

6.5.2.2. - Tmin storage

If the temperature measured at the corresponding storage sensor falls below this value outside of the defined heating times, heating is activated anyways.

6.5.2.3. - Tset storage

If the temperature measured at the corresponding storage sensors falls below this value during the defined heating times, heating is activated.

Special functions

6.5.2.4. - Switch-off hysteresis for storage heating

The storage target temperature is calculated from T_{min} or T_{set} storage at the given operating time plus the hysteresis set here. If the target temperature at the corresponding storage sensor is reached, storage heating is switched off.

6.5.2.5. - Heating times

Operating times for storage heating.

In this menu, the operating times for the storage heating can be adjusted, where 3 periods can be set per day which can be copied to subsequent days.

6.5.3. - Storage stratification

Storage stratification switches a valve in the primary return flow depending on the temperature. Temperature is measured in the primary circuit and optionally in the middle zone of the storage.

6.5.3.1. - Storage stratification

Switch stratification on or off.

6.5.3.2. - ΔT return storage

Temperature difference for stratification

If the temperature in the primary circuit exceeds the temperature difference set here, the valve is switched to load the upper storage zone.

If the temperature drops below this temperature, the valve is switched off again.

When no storage sensor is connected, a temperature of 25°C is assumed.

6.5.4. - Parallel operation V1

The relay is switched on at the same time as the set output signal **V1/V2** for 0-10V/ PWM is switched on.



Atención

For high-efficiency pumps with 0-10V / PWM signal input, power supply can be realised by using the additional function „always on“ or „parallel operation“ for relay 1-3.

6.5.4.1. - Parallel operation V1

Activate this function further it is possible to activate this function inverted.

6.5.4.2. - Delay

The relay switches on after this delay time.

6.5.4.3. - Followup time

Follow up time for the relay after output V1/V2 is switched off.

Special functions

6.5.5. - Parallel operation V2

See „6.5.4. - Parallel operation V1

6.5.6. - Always on

Relay is permanently switched on.

6.6. - Relay 2

See „6.5. - Relay functions 1

6.7. - Relay 3

See „6.5. - Relay functions 1

6.8. - Signal V2

With this function the PMW/0-10V output 2 is used for an additional high-efficiency pump. If a pump function is activated (e.g. circulation), additional parameters for pump settings V2 and V2 speed -control have to be set. For other functions (e.g. zone valve) the output signal switch from 0 to 10 V. For other switching variants an additional relay box can be used to switch a potential-free relay at this output.

Please note the technical information about the PMW/0-10V outputs („B.1 - Specifications“ on page 6).

6.8.1. - Signal V2

See „6.5. - Relay functions 1

6.9. - Pressure monitor

The relay is switched on when the pressure drops below set minimum or exceeds the set maximum pressure.

6.9.1. - Pressure monitor

This menu is used to configure the system pressure monitoring via direct sensor. As soon as the set limits are exceeded, the relay is switched on.

6.9.2. - RPS1 / RPS2

Type of pressure sensor

This menu is used to determine the type of pressure sensor used. Please note: If e.g. VFS1 is connected, RPS1 option is not shown.

6.9.3. - Pmin

Minimum pressure. If this value is undershot, an error message is displayed and the relay is switched on.

6.9.4. - Pmax

Maximum pressure. If this value is exceeded, an error message is displayed and the relay is switched on.

Special functions

6.10. - Sensor calibration

Deviations in the temperature values displayed, for example due to cables which are too long or sensors which are not positioned optimally, can be compensated for manually here. The settings can be made for each individual sensor in steps of 0.5°C.



Caution

Settings are only necessary in special cases at the time of initial commissioning by the specialist. Incorrect measurement values can lead to unpredictable errors.

6.11. - Commissioning

Starting the commissioning help guides you in the correct order through the basic settings necessary for commissioning, and provides brief descriptions of each parameter in the display. Pressing the “esc” key takes you back to the previous value so you can look at the selected setting again or adjust it if desired. Pressing the “esc” more than once takes you back to the selection mode, thus cancelling the commissioning help. (see also 5.1)



Caution

May only be started by a specialist during commissioning! Observe the explanations for the individual parameters in these instructions, and check whether further settings are necessary for your application.

6.12. - Factory settings

All of the settings that have been made can be reset, thus returning the controller to its delivery state.



Caution

The entire parametrisation, analyses, etc. of the controller will be lost irrevocably. The controller must then be commissioned once again.

6.13. - Time & Date

This menu is used to set the current time and date.



Caution

For proper functioning of the controller and statistics for the system data it is essential for the time to be set accurately on the controller. Please note that the clock continues to run for about 24 hours if the mains voltage is interrupted, and after that has to be reset.

Special functions

6.14. - Daylight saving time

When this function is active, the controller's clock changes automatically to and from DST (DST, Daylight Saving Time).

6.15. - Eco display mode

When this function is active, the controller's backlight is automatically switched off when no button has been pressed for 2 minutes.



Caution

If a message is waiting, the backlight is not switched off.

6.16. - Temperature unit

This menu changes the displayed temperature unit.

Menu lock

7. - Menu lock



Menu “7. Menu lock” can be used to secure the controller against unintentional changing of the set values.



The menu is closed by pressing “esc” or selecting “Exit menu lock”.

7.1. - Menu lock

The menus listed below remain completely accessible despite the menu lock being activated, and can be used to make adjustments if necessary:

1. Measurement values
2. Analysis
3. Display mode
8. Menu lock
9. Service values

To lock the other menus, select “Menu lock on”.

To enable the menus again, select “Menu lock off”.

7.2. - Expert mode

This menu is used to switch between expert mode, in which all settings are available, and simple mode, in which only the following menus are available:

1. Measurement values
2. Statistics
- 4.3 Tset
- 4.4.1 Circulation mode
- 4.4.7 Circ. Periods
- 6.10 Time and Date
7. Menu lock without 7.1
9. Language

Service values

8. - Service values

8.2. Hot water	45 °C
8.3. Circulation	43 °C
8.4. Cold water	12 °C

▲ ▼

The menu "8. Service values" can be used for remote diagnosis by a specialist or the manufacturer in the event of an error, etc.



Caution

Enter the values at the time when the error occurs e.g. in the table.



The menu can be closed at any time by pressing "esc".

8.1.	
8.2.	
8.3.	
8.4.	
8.5.	
8.6.	
8.7.	
8.8.	
8.9.	
8.10.	
8.11.	
8.12.	
8.13.	
8.14.	
8.15.	
8.16.	
8.17.	
8.18.	
8.19.	
8.20.	
8.21.	
8.22.	
8.23.	
8.24.	
8.25.	
8.26.	
8.27.	
8.28.	
8.29.	
8.30.	

8.31.	
8.32.	
8.33.	
8.34.	
8.35.	
8.36.	
8.37.	
8.38.	
8.39.	
8.40.	
8.41.	
8.42.	
8.43.	
8.44.	
8.45.	
8.46.	
8.47.	
8.48.	
8.49.	
8.50.	
8.51.	
8.52.	
8.53.	
8.54.	
8.55.	
8.56.	
8.57.	
8.58.	
8.59.	
8.60.	

Language

9. - Language



Menu “9. Language” can be used to select the language for the menu guidance. This is queried automatically during initial commissioning. The choice of languages may differ, however, depending on the device design. Language selection is not available in every device design!

Malfunctions

Z.1 Malfunctions with error messages

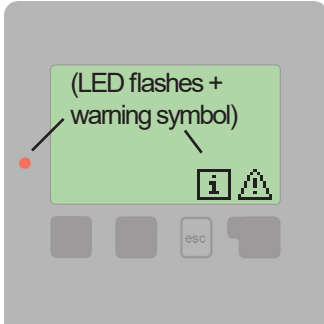

If the controller detects a malfunction, the red light flashes and the warning symbol also appears in the display. If the error is no longer present, the warning symbol changes to an info symbol and the red light no longer flashes. To obtain more detailed information on the error, press the key under the warning or info symbol.



Do not try to deal with this yourself.
Consult a specialist in the event of an error!

Possible error messages:

Notes for the specialist:

Sensor x defective

Means that either the sensor, the sensor input at the controller or the connecting cable is/was defective. (Resistance table on page 5)

Time & date

This display appears automatically after a mains failure because the time&date have to be checked, and reset if necessary.

Temperature < 50

The temperature at the optional sensor S3 fell below 50 °C.
This means that the primary temperature is too low, so it could be possible to produce not enough hot water

Temperature > 70

The temperature at the optional sensor S3 exceeded 70 °C.
This means that the primary temperature is too high, so it is possible to have limescale in the exchanger

Malfunctions

Z.2 Replacing the fuse



Repairs and maintenance may only be performed by a specialist. Before working on the unit, switch off the power supply and secure it against being switched on again! Check for the absence of power!



Only use the supplied spare fuse or a fuse of the same design with the following specifications: T2A 250V

If the mains voltage is switched on and the controller still does not function or display anything, then the internal device fuse may be defective. In that case, open the device as described under 3.1, remove the old fuse and check it. Exchange the defective fuse for a new one, locate the external source of the error (e.g. pump) and exchange it. Then first recommission the controller and check the function of the switch outputs in manual mode as described under 9.2.

Fig.Z.2.1

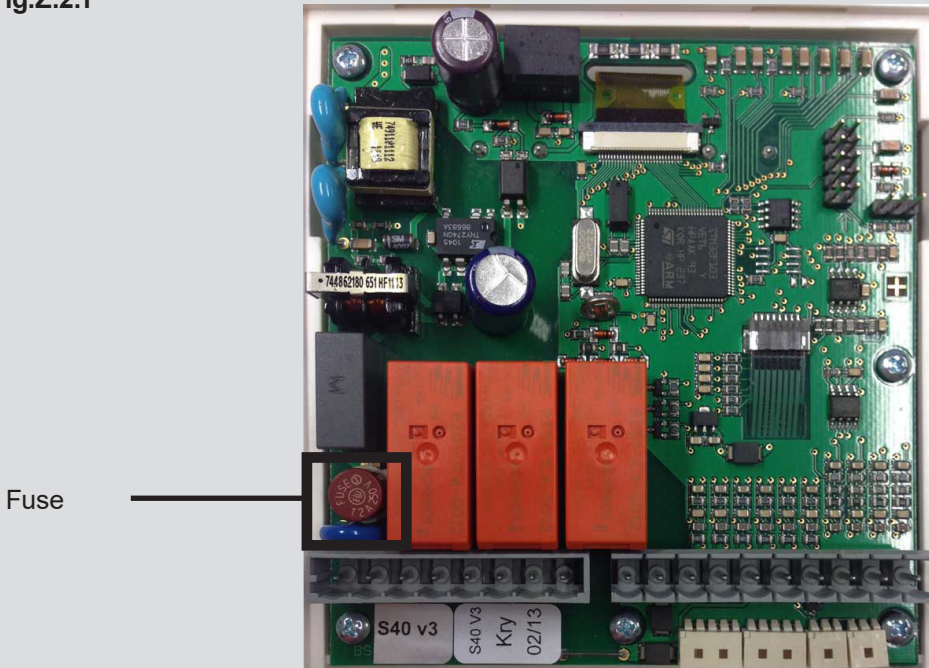

Maintenance

Z.3. Maintenance



Caution

In the course of the general annual maintenance of your heating system you should also have the functions of the controller checked by a specialist and have the settings optimised if necessary.

Performing maintenance:

- Check the date and time (see 11.1)
- Assess/check plausibility of analyses (see 7.)
- Check the error memory (see 7.5)
- Verify/check plausibility of the current measurement values (see 6.)
- Check the switch outputs/consumers in manual mode (see 9.2)
- Poss. optimise the parameter settings

Hydraulic variant set:

Commissioned on:

Commissioned by:

Notes:

Final declaration:

Although these instructions have been created with the greatest possible care, the possibility of incorrect or incomplete information cannot be excluded. Subject as a basic principle to errors and technical changes.

Specialist dealer: